

ProMax Resista/nm



FEATURES

- High output luminaire, up to 30,000 raw lumens.
- Fluorescent system provides energy savings up to 50% when compared to HID.
- Third party certified for operation in high ambient temperatures, up to 55°C (131°F).
- Multi voltage electronic ballast resistant to brownouts or voltage and frequency fluctuations.
- Hose tested at 1500 PSI for 60 minute duration, at 5 feet and 10 feet distance, nozzle dispersion 0 degree.
- USDA compliant materials.
- Meets Canadian Processed Products Regulations C.R.C. c291.
- Polybutylene Terephthalate (PBT) end cap provides the broadest range of chemical resistance.
- Field replaceable silicone gasket adhered in end cap.
- Options include: Stainless steel end caps, quick disconnect receptacle, stainless steel quick disconnect straps and center stud mount end caps.
- Optional self contained emergency battery backup ballasts.
- Emergency models feature EM markings or red end caps (center stud models only).

APPLICATIONS

- High, mid & low bay
- High pressure hose down areas
- Watertight requirements
- Dusttight requirements
- Food & beverage processing facilities
- Waste water treatment plants
- Pulp & paper production

APPROVALS

- Enclosed & Gasketed
- Type 4
- Conforms to IP66
- NSF

STANDARDS

- UL 924 - Emergency Lighting Equipment
- UL 1598 - Luminaires
- CSA - Class 3425 03
- Canadian Processed Products Regulations C.R.C. c291
- CSA - Class 3425 83
- NSF/ANSI 2-2007 Food Contact (WPS version)
- NSF/ANSI 2-2007 Splash Zone

TECHNICAL SPECIFICATIONS

HOUSING/LENS

End caps polybutylene terephthalate (PBT) or stainless steel, optional polycarbonate center stud. Clear, impact resistant, acrylic lens.

HARDWARE

External hardware stainless steel.

REFLECTOR

Extruded aluminum assembly, coated gloss white.

GASKETS

One piece silicone.

MOUNTING

Cable, fixed, nylon coated suspended cable, wall mount, or stainless steel straps. Other options available, see MOUNTING OPTIONS.

LAMP HOLDERS

Locking sockets on Bi-Pin models made of industrial grade high temperature PBT. Spring loaded polycarbonate sockets on all HO models.

ENTRIES

Single or feed-through 1/2" NPT.

LAMP TYPES

See ORDERING REFERENCES. Lamps not provided.

BALLAST

120 to 277 volt 50/60Hz electronic.

Lamp Wattage	Ballast/Socket Type	ANSI Lamp Code	Starting Temp	Maximum Ambient*	Supply Wire
17	T8 Bi-Pin G13	F17-T8	0°F / -18°C	55°C	90°C
32	T8 Bi-Pin G13	F32-T8	-20°F / -29°C	55°C	90°C
24/54	T5HO Mini Bi-Pin G5	F24/F54-T5HO	-20°F / -29°C	40°C	90°C
14/28	T5 Mini Bi-Pin G5	F14/F28-T5	0°F / -18°C	40°C	90°C
44/86	T8HO RDC R17d	F48/F96-T8HO	-20°F / -29°C	40°C	90°C
35/60/110	T12HO RDC R17d	F24/F48/F96-T12HO	-20°F / -29°C	40°C	90°C

*Consult factory for optional higher ambient models.

EMERGENCY BATTERY BACKUP BALLAST

Optional, self contained 90 minute minimum for all lamp types. 120 minutes minimum for F32T8 one lamp. Starting temperature 32°F/0°C.

ORDERING REFERENCES

1. Series
WP
WPS - SS end caps

2. Length (nominal)
2 - 2 foot
4 - 4 foot
8 - 8 foot

3. Number of Lamps
2 - 2 lamps
3 - 3 lamps (Lamp Types 1, 5 & 6)
4 - 4 lamps
(4 ft fixture, Lamp Types 5 & 6 only. 8 ft fixtures with four 4 ft lamps, Lamp Types 1, 5, 6 & 8)
6 - 6 lamps (8 ft fixture with six 4 ft lamps, Lamp Types 1, 5 & 6)

4. Lamp Types
1 - 17/32/59 - 2 ft F17, 4 ft F32 - T8 Bi-Pin or 8 ft F96 Single Pin
3 - 60ES/75 - 8 ft F96 - T12 Single Pin
5 - 24/54 - 2 ft F24 or 4 ft F54 - T5HO Mini Bi-Pin
6 - 14/28 - 2 ft F14 or 4 ft F28 - T5 Mini Bi-Pin
7 - 44/86 - 4 ft F48 or 8 ft F96 - T8HO RDC
8 - 35/60/110 - 2 ft F24, 4 ft F48 or 8 ft F96 - T12HO RDC

5. Voltage / Frequency
7 - 120 to 277 Volt 50/60 Hz
6 - 347 Volt 60 Hz, consult factory for availability
9 - 480 Volt 60 Hz, consult factory for availability

6. Mounting / Entries
0 - Standard End Cap. with 1 strain relief connector
1 - Standard End Cap, feed-thru with 2 strain reliefs
2 - Center Stud End Cap, with 1 strain relief connector, with hanger brackets
3 - Center Stud End Cap, feed-thru with 2 strain reliefs, with hanger brackets
4 - Same as #2, with wall mount brackets
5 - Same as #3, with wall mount brackets
6 - Same as #2, with WP1050MTK straps
7 - Same as #3, with WP1050MTK straps
8 - Same as #0, with WP1050MTK straps
9 - Same as #1, with WP1050MTK straps

7. Special Options
EM2* - Emergency Battery Backup Ballast, 1 lamp, 277v max
EM3* - Emergency Battery Backup Ballast, high lumen, 1 lamp, 277v max
EMT2* - Emergency Battery Backup Ballast, 1 lamp, 277v max, test switch
EMT3* - Emergency Battery Backup Ballast, high lumen, 1 lamp, 277v max, test switch
L** - Lamps
S - Switch, on/off
W3 - 3 ft 16/3 Cord, change suffix 3 for longer cord (WP163SR-3)
Q - Quick Disconnect Receptacle, (WP003MR)
(Order connecting cords separately)

*For T5 & T5HO, EM Ballast is fixed voltage, 120 or 277v, 50/60Hz.
**Lamps are not included unless option "L" is specified.

Notes:
1. See ACCESSORIES for other items & mounts.
2. Consult factory for options not listed above.

SPARE PARTS

Part No.	Description	Part No.	Description	Part No.	Description
FX5350	BALLAST 120-277V, 60Hz 2 x 14, F14T5	FX3574	LAMP, 28w,	370-0104	GASKET, O-ring for stud
FX5350	BALLAST 120-277V, 60Hz 2 x 28, F28T5	FX3568	LAMP, 24w, F24T5HO	312-0703	STUD, SS secures end cap to inner channel
FX5307	BALLAST 120-277V, 60Hz 2 x 24, F24T5HO	FX3567	LAMP, 54w, F54T5HO	370-0155	GASKET, cord connector or optional receptacle
FX5305	BALLAST 120-277V, 60Hz 2 x 54, F54T5HO	FX3528	LAMP, 17w, F54T5HO	355-0538	CONNECTOR, cord strain relief, 1/2" NPT non-metallic
FX5340	BALLAST 120-277V, 60Hz 2 x 17, F54T5HO	FX3527	LAMP, 32w, F32T8	007-4000	TUBE, acrylic, 4 ft. models
FX5340	BALLAST 120-277V, 60Hz 2 x 32, F32T8	FX3572	LAMP, 59w, F96T8	007-8000	TUBE, acrylic, 8 ft. models
FX5322	BALLAST 120-277V, 60Hz 2 x 59, F96T8	FX3565	LAMP, 44w, F48T8HO	007-2000	TUBE, acrylic, 2 ft. models
FX5349	BALLAST 120-277V, 60Hz 2 x 44, F48T8HO	FX3566	LAMP, 86w, F96T8HO	007-1050	END CAP, electrical end (1/2" NPT hub)
FX5369	BALLAST 120-277V, 60Hz 2 x 86, F96T8HO	FX3576	LAMP, 60w ES, F96T12ES	007-1000	END CAP, non-electrical end
FX5062	BALLAST 120-277V, 60Hz 2 x 60ES, F96T12ES	FX3523	LAMP, 75w, F96T12	FX6091EN	END CAP, center stud, electrical end (1/2" NPT hub)
FX5062	BALLAST 120-277V, 60Hz 2 x 75, F96T12	FX3507	LAMP, 35w, F24T12HO	FX6091BN	END CAP, center stud, non-electrical end
FX5334	BALLAST 120-277V, 60Hz 2 x 35, F24T12HO	FX3505	LAMP, 60w, F48T12HO	FX6841	END CAPS, stainless steel
FX5334	BALLAST 120-277V, 60Hz 2 x 60, F48T12HO	FX3550	LAMP, 110w, F96T12HO	FX6841	END CAPS, center stud, stainless steel,
FX5338	BALLAST 120-277V, 60Hz 2 x 110, F96T12HO	758-0464	LAMP HOLDER, RDC, spring loaded, HO models	FFSET	END CAPS, center stud, stainless steel,
FX5135U	EMERGENCY BATTERY BACKUP BALLAST, EM2/EMT2, 120-277V for T8, T8HO, T12 & T12HO	758-0465	LAMP HOLDER, RDC, fixed, HO models	FX6091	END CAPS, center stud red (for EM models)
FX5316	EMERGENCY BATTERY BACKUP BALLAST, EM2/EMT2/EM3/EMT3, 120 or 277V for T5 & T5HO	754-8701	LAMP HOLDER, Bi-Pin, T8 & T12 models	SETEM	
FX5095U	EMERGENCY BATTERY BACKUP BALLAST, EM3/EMT3, 120-277V for T8, T8HO, T12 & T12HO	752-0002	LAMP HOLDER, fixed, T5	007-1500	GASKET, O-ring for either end cap
FX3573	LAMP, 14w, F14T5	755-0214	LAMP HOLDER, Single Pin, fixed		
		755-2015	LAMP HOLDER, Single Pin, spring loaded		
		312-0104	NUT, stainless steel closed end		

ProMax **Resista**/nm

DIMENSIONS

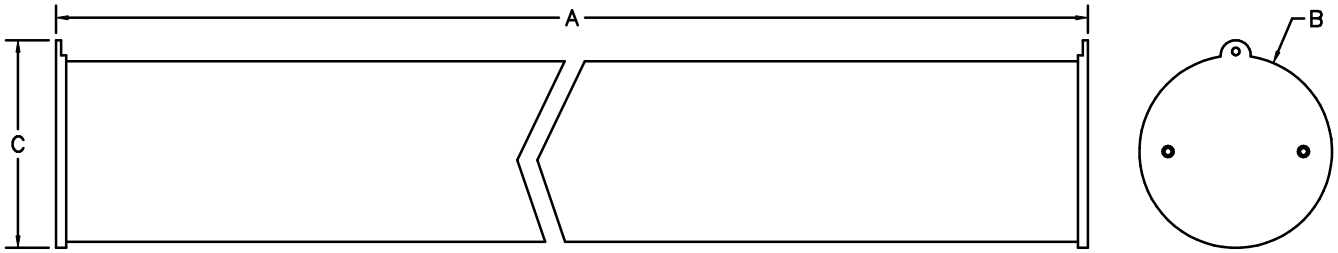

Nominal Length	Dimensions in Inches / Centimeters			Carton W x D x L Inches	Nominal Weight	
	A	B	C		Lbs	Kg
2 Foot	25.0 / 63.5	6.4 / 16.3	7.03 / 17.86	8¾ x 6¼ x 31⅞	12.4	5.6
4 Foot	49.0 / 124.5	6.4 / 16.3	7.03 / 17.86	8 x 8 x 51¼	20.3	9.2
8 Foot	97.0 / 246.4	6.4 / 16.3	7.03 / 17.86	8 x 8 x 99¼	36.1	16.4

ACCESSORIES

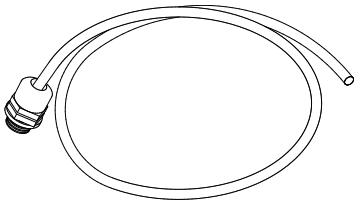

WP163SR-6

Cord assembly - strain relief connector and 6 feet of #16/3 cable. If longer cable required change suffix "6" to length needed.

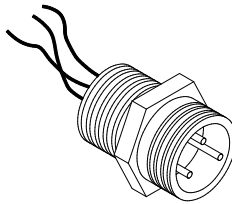

WP003MR

Quick disconnect receptacle. Required when #WP163FP-6 is used.

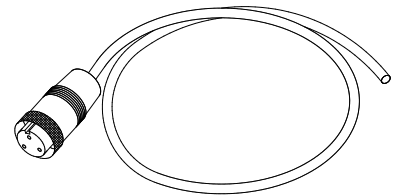

WP163FP-6

Cord assembly - molded plug & 6 feet of #16/3 cable. If longer cable required change suffix "6" to length needed.

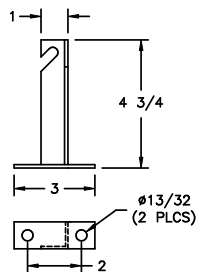

FX7090

Wall Mount Bracket
For Center Stud end caps.

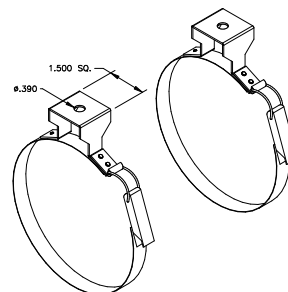

WP1050MTK

2 Quick Release Stainless steel straps. Included with MOUNTINGS 6, 7, 8 & 9.

MOUNTING OPTIONS

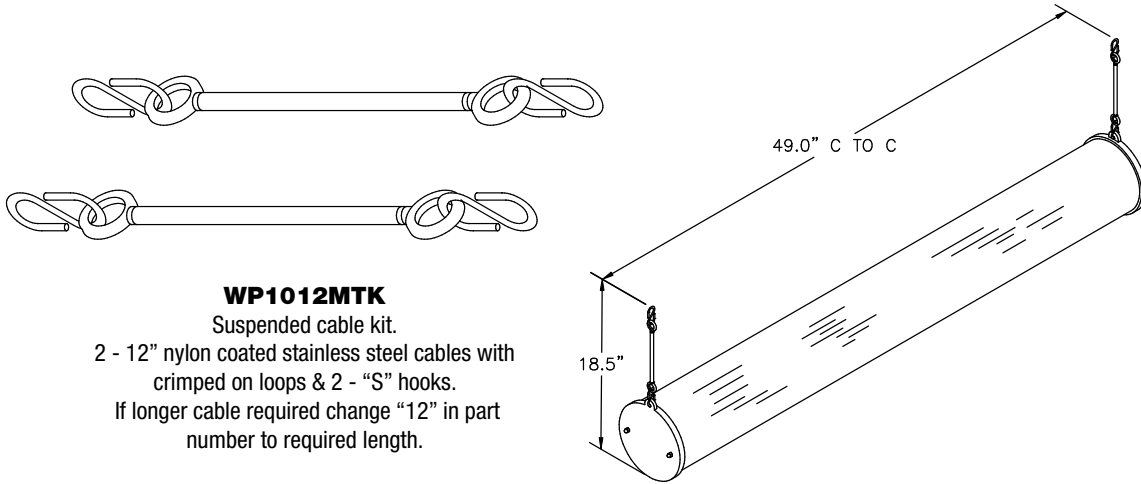

WP1012MTK

Suspended cable kit.

2 - 12" nylon coated stainless steel cables with crimped on loops & 2 - "S" hooks.

If longer cable required change "12" in part number to required length.

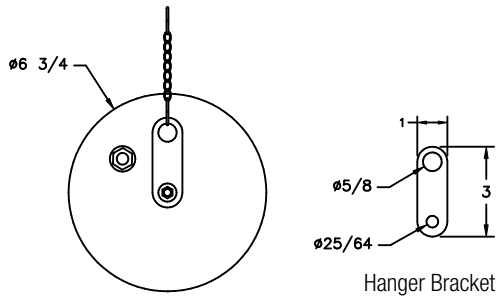

CENTER STUD END CAP

Center Stud end caps include hanger bracket and stainless steel chain mount. MOUNTINGS 2 & 3.